

More Precision.



optris[®] CT laser 3M

Non-contact temperature measurement with precise aiming from 50°C to 600°C



FEATURES

- Accurate temperature measurements of metals, secondary metal processing and ceramic materials
- Double laser aiming marks real spot location at any distance
- Optical resolution up to 100:1 with selectable focus
- Temperature ranges from 50°C to 600°C, measuring spots up from 0,7 mm and response times up from 1ms
- Usable up to 85°C ambient temperature without cooling
- Short measuring wave length of 2,3 μm reduces error of temperature readings on surfaces with low or unknown emissivity

General specifications	
Environmental rating	IP 65 (NEMA-4)
Ambient temperature	sensing head: -40 - 85°C electronics: 0 - 85°C
Storage temperature	sensing head: -40 - 125°C electronics: -40 - 85°C
Relative humidity	10 - 95 %, non condensing
Vibration (sensor)	IEC 68-2-6: 3 G, 11-200 Hz, any axis
Shock (sensor)	IEC 68-2-27: 50 G, 11 ms, any axis
Weight	sensing head 600 g electronics 420 g
Electrical specifications	
Outputs/analog	channel 1: 0/4 - 20 mA, 0 - 5/10 V, thermocouple J, K channel 2: sensing head temperature (-40 - 85°C as 0 - 5 V or 0 - 10 V), alarm output
Alarm output	Open - collector (24V/50mA)
Optional:	relay: 2 x 60 V DC/42 V AC _{eff} ; 0.4 A; optically isolated
Outputs/digital (optional)	USB, RS232, RS485, CAN, Profibus DP, Ethernet
Output impedances	mA max. 500 Ω (with 5 - 36 V DC) mV min. 100 k Ω load impedance thermocouple 20 Ω
Inputs	programmable functional inputs for external emissivity adjustment, ambient temperature compensation, trigger (reset of hold functions)
Cable length	3 m (standard), 8 m, 15 m
Current draw	max. 160 mA
Power supply	8 - 36 V DC
Laser 635 nm	1mW, ON/OFF via electronic box or software

Measurement specifications	
Temperature range (scalable via programming keys or software) ¹⁾	50 - 375°C (3ML) 100 - 600°C (3MH)
Spectral range	2,3 μm
Optical resolution (90% Energy)	40:1 (3ML) 100:1 (3MH)
System accuracy ²⁾ (at ambient temperature 23 \pm 5°C)	\pm (0,3% of reading +2°C)
Repeatability (at ambient temperature 23 \pm 5°C)	\pm (0,1% of reading +1°C)
Temperature resolution (digital)	0,1 K
Exposure time (90% signal) ³⁾	1 ms
Emissivity/Gain (adjustable via programming keys or software)	0.100 - 1.100
Transmissivity/Gain (adjustable via programming keys or software)	0.100 - 1.000
Signal processing (parameter adjustable via programming keys or software, respectively)	peak hold, valley hold, average; extended hold function with threshold and hysteresis

¹⁾ Tobject > Tsensing head +25°C

²⁾ E = 1, response time 1s

³⁾ with dynamic adaptation at low signal levels

optris® CT laser 3M

Optical specifications

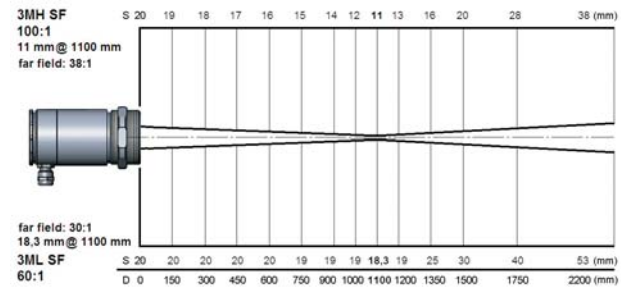
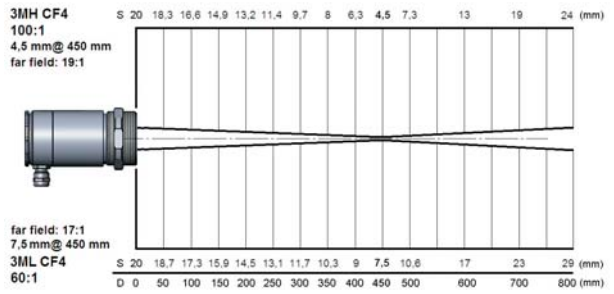
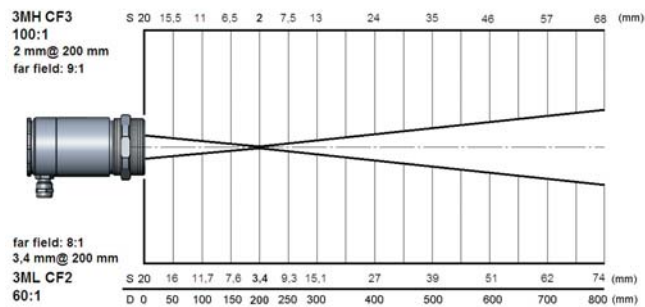
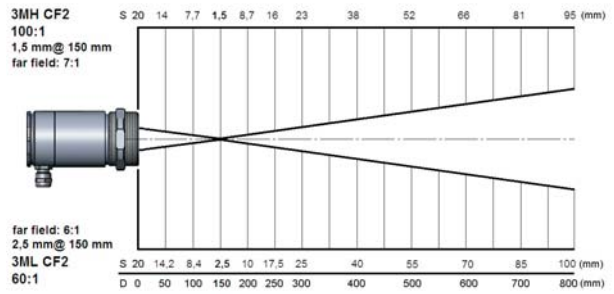
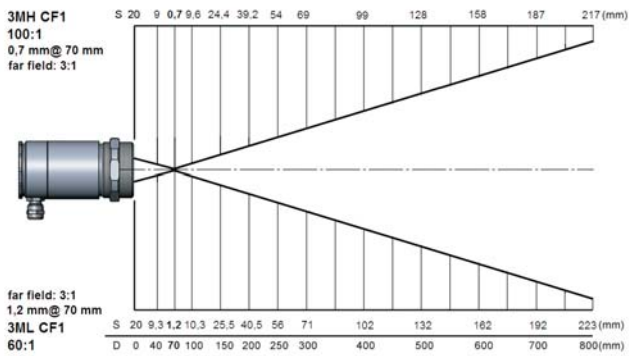

Dimensions

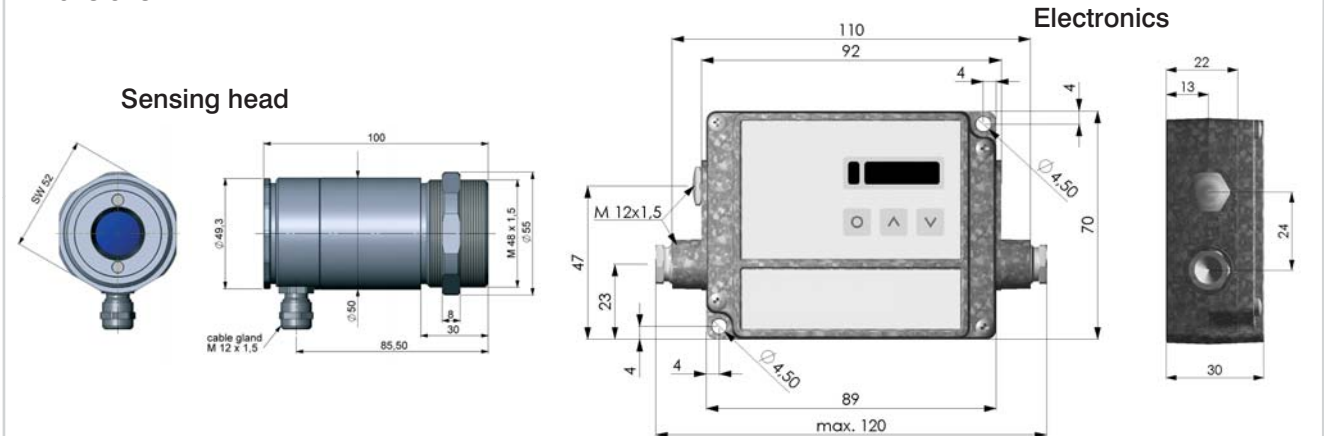

CompactConnect Software

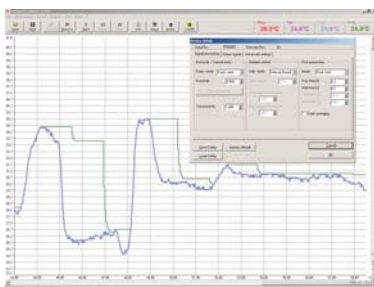

- Software for easy sensor setup and remote controlling, supports multi tasking
- Graphic display for temperature trends and automatic data logging for analysis and documentation with 1 ms response time
- Adjustment of signal processing functions and programming of outputs and functional inputs of the sensor
- Automatic emissivity adjustment
- The software CompactConnect allows to customize the sensor to application needs of the user

Optris GmbH

Ferdinand-Buisson-Str. 14
13127 Berlin/Germany

Tel. +49 (0) 30 500 197-0
Fax +49 (0) 30 500 197-10

Development and sales of portable and stationary infrared measuring instruments.

info@optris.de
www.optris.de

Specifications are subject to change without notice.
CTlaser3M-DS-E2009-03-A

