

More Precision.

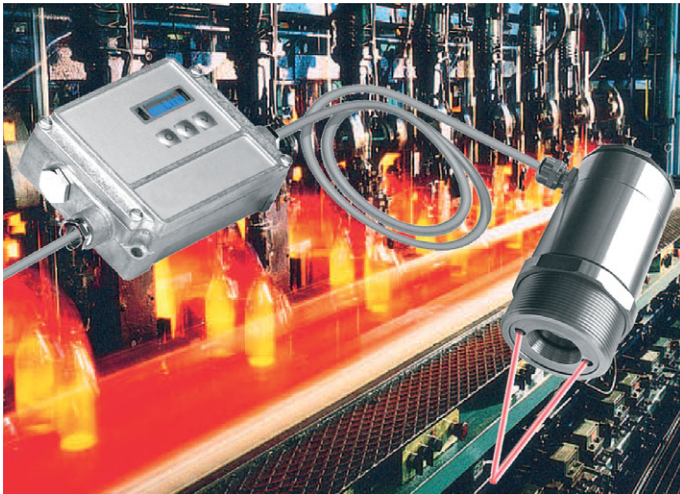

optris[®] CT glass

Non-contact glass temperature measurement with precise aiming from 100°C to 1650°C



FEATURES

- Accurate glass temperature measurements on flat glass lines, container glass machines, bulb manufacturing, car glass finishing and the production of solar panels in the range of 100°C up to 1650°C
- Double laser aiming marks real spot location and spot size up from 1 mm at any distance
- Usable in all modern applications where "size of spot matters"
- Optics 70:1 with selectable focus, compact sensor head size
- Usable up to 85°C ambient temperature without cooling and automatic laser switch off at 50°C
- Cooling and protection accessories for harsh environmental conditions

General specifications	
Environmental rating	IP 65 (NEMA-4)
Ambient temperature	sensing head: -20 - 85°C (50°C with laser ON) electronics: 0 - 65°C
Storage temperature	sensing head: -40 - 85°C electronics: -40 - 85°C
Relative humidity	10 - 95 %, non condensing
Vibration (sensor)	IEC 68-2-6: 3 G, 11-200 Hz, any axis
Shock (sensor)	IEC 68-2-27: 50 G, 11 ms, any axis
Weight	sensing head 600 g electronics 420 g
Electrical specifications	
Outputs/analog	channel 1: 0/4 - 20 mA, 0 - 5/10 V, thermocouple J, K channel 2: sensing head temperature (-40 - 85°C as 0 - 5 V or 0 - 10 V), alarm output
Optional:	relay: 2 x 60 V DC/42 V AC _{eff.} ; 0.4 A; optically isolated
Outputs/digital (optional)	USB, RS232, RS485, CAN, Profibus DP
Output impedances	mA max. 500Ω (with 5 - 36 V DC) mV min. 100 kΩ load impedance thermocouple 20Ω
Inputs	programmable functional inputs for external emissivity adjustment, ambient temperature compensation, trigger (reset of hold functions)
Cable length	3 m (standard), 8 m, 15 m
Current draw	max. 160 mA
Power supply	8 - 36 V DC
Laser 635 nm	1mW, ON/OFF via electronic box or software

Measurement specifications	
Temperature range (scalable via programming keys or software)	100 - 1200°C (G5L) 250 - 1650°C (G5H)
Spectral range	5.2 μm
Optical resolution	45:1 (G5L) 70:1 (G5H)
Selectable focus (G5H) (for G5L - Models see optical charts)	CF1 1 mm @ 70 mm CF2 2.2 mm @ 150 mm CF3 2.9 mm @ 200 mm CF4 6.5 mm @ 450 mm SF 17 mm @ 1200 mm
System accuracy (at ambient temperature 23 ±5°C)	±1 % or ±1°C ¹
Repeatability (at ambient temperature 23 ±5°C)	±0.5 % or ±0.5°C ¹
Temperature resolution (NETD)	0.1°C / 1°C
Response time (90% signal)	80 ms (G5H) 120 ms (G5L)
Emissivity/Gain (adjustable via programming keys or software)	0.100 - 1.100
Transmissivity/Gain (adjustable via programming keys or software)	0.100 - 1.000
Signal processing (parameter adjustable via programming keys or software, respectively)	peak hold, valley hold, average; extended hold function with threshold and hysteresis
Certificate of calibration	optional

¹ whichever is greater

optris® CT glass

Optical specifications

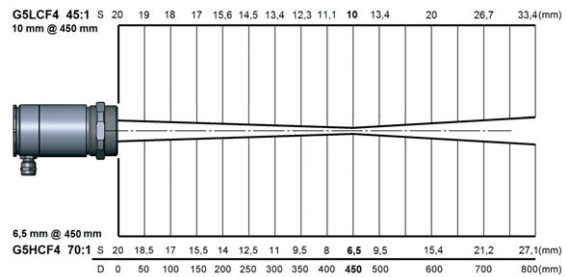
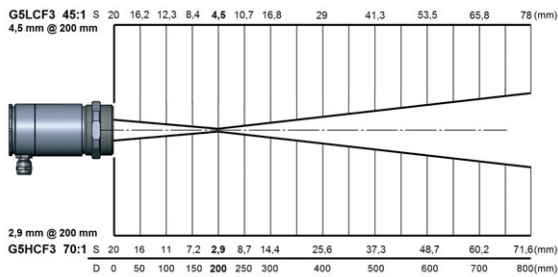
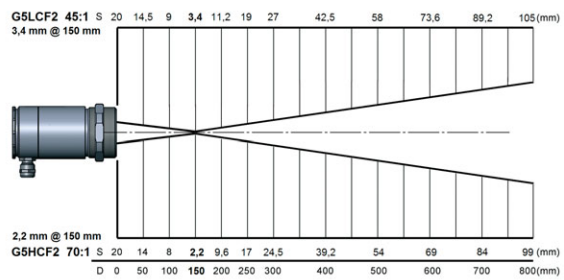
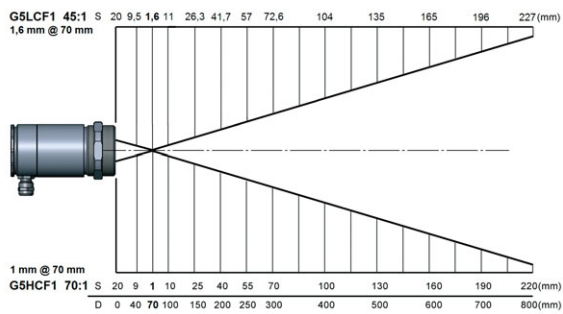

Dimensions

Sensing head

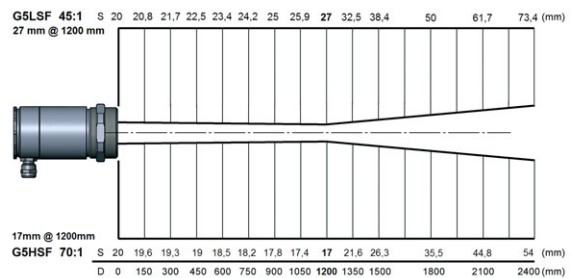
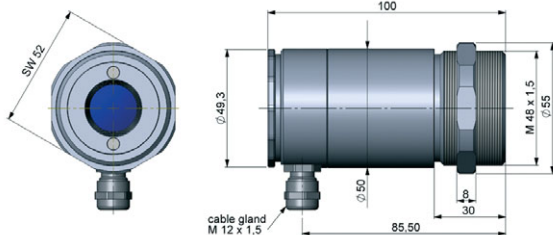

Electronics

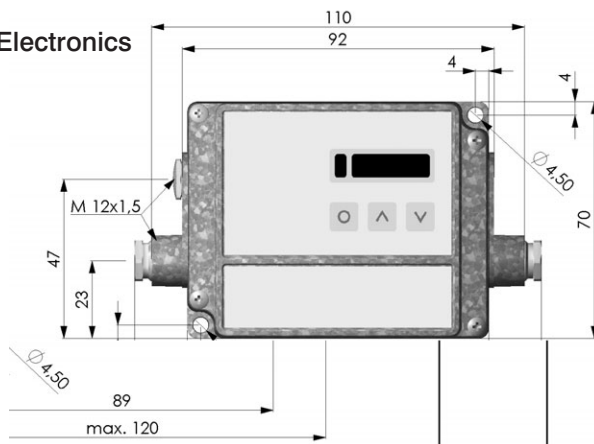

CompactConnect Software

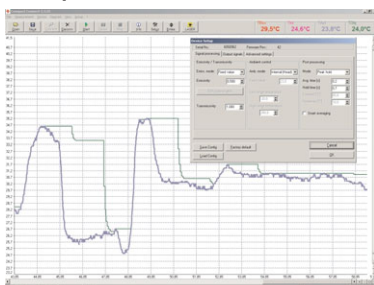

- Software for easy sensor setup and remote controlling, supports multi tasking
- Graphic display for temperature trends and automatic data logging for analysis and documentation with 1 ms response time
- Adjustment of signal processing functions and programming of outputs and functional inputs of the sensor
- Automatic emissivity adjustment
- The software CompactConnect allows to customize the sensor to application needs of the user