

LMK 457

Hydrostatic Level Transmitter for Shipbuilding and Offshore

- ▶ capacitive ceramic sensor
- ▶ materials: 1.4571 (316Ti); optional CuNiFe
- ▶ different types of construction
- ▶ nominal pressure ranges from 0 ... 40 cmH₂O up to 0 ... 200 mH₂O (0 ... 40 mbar up to 0 ... 20 bar)

The hydrostatic level transmitter LMK 457 has been designed especially for shipbuilding and offshore applications. The transmitter is suitable for level measurement in open tanks, containers or reservoirs.

Based on a rugged and reliable capacitive ceramic sensor this transmitter is qualified for measuring small filling heights with high accuracy. Due to the different housing materials such as stainless steel 1.4571 (316Ti) or the special copper-nickel-alloy CuNiFe in combination with several mounting types, the transmitter covers a lot of applications in shipbuilding and offshore business. Usage with many fluids or pasty media, compatible with the media wetted parts is possible.

The hydrostatic level transmitters as a standard comply with the requirements of Germanischer Lloyd (GL) and Det Norske Veritas (DNV). Additionally, the devices can optionally be delivered with ATEX certificate.

Typical areas of use are:

- ▶ ballast tanks
- ▶ fuel and oil tanks
- ▶ service and waste water tanks

- ▶ small thermal effect
- ▶ excellent linearity
- ▶ good long term stability
- ▶ 0.175 % / 0.125 % FSO BFSL (0.35 % / 0.25 % FSO IEC 60770)
- ▶ **option Ex version (only for 4 ... 20 mA / 2-wire) IExU05 ATEX 1070 X**
- ▶ optional:
 - cable protection
 - diaphragm in Al₂O₃ 99.9 %
 - customer versions on request

Characteristics

LMK 457
Hydrostatic Level Transmitter



LMK 457

Hydrostatic Level Transmitter

Technical Data

Input pressure range

Nominal pressure ¹ [bar]	0.04	0.06	0.1	0.16	0.25	0.4	0.6	1	1.6	2.5	4	6	10	16	20
Level [mH ₂ O]	0.4	0.6	1	1.6	2.5	4	6	10	16	25	40	60	100	160	200
Permissible overpressure [bar]	2	2	4	4	6	6	8	8	15	25	25	35	35	60	60

Output signal / Supply

2-wire	4 ... 20 mA / V _s = 9 ... 32 V _{DC} (rated: 24 V _{DC})	Ex-protection: V _s = 12 ... 28 V _{DC}
--------	--	---

Performance

Accuracy	IEC 60770 ²	BFSL
	standard: ≤ ± 0.35 % FSO option: ≤ ± 0.25 % FSO	standard: ≤ ± 0.175 % FSO option: ≤ ± 0.125 % FSO
Permissible load	R _{max} = [(V _s - V _{s min}) / 0.02] Ω	
Long term stability	≤ ± 0.1 % FSO / year	
Influence effects	supply: 0.05 % FSO / 10 V	load: 0.05 % FSO / kΩ
Response time	< 200 msec.	

Thermal effects (offset and span)

Thermal error	≤ ± 0.1 % FSO / 10 K
in compensated range	0 ... 80 °C

Mechanical stability

Vibration	4 g (according to GL: curve 2 / according to DNV: class B / basis: IEC 60068-2-6)
-----------	---

Permissible temperatures

Medium	-25 ... 80 °C	Ex-protection: application in zone 0: -20 ... 60 °C application in zone 1 or higher: -25 ... 70 °C
Storage	-40 ... 80 °C	

Electrical protection³

Reverse polarity protection	no damage, but also no function
Electromagnetic compatibility	emission and immunity according to - EN 61326 - Germanischer Lloyd (GL) - Det Norske Veritas (DNV)
Option Ex-protection	zone 0 ⁴ : II 1 G EEx ia IIB T4 zone 20: II 1D EEx IP68 T=85 °C (valid for screw-in and flange transmitters) safety technical maximum values: U _i = 28 V, I _i = 93 mA, P _i = 660 mW, C _i = 146.3 nF, L _i = 5 μH

¹ available in gauge, sealed gauge and absolute; nominal pressure ranges sealed gauge and absolute from 1 bar

² accuracy according to IEC 60770 – limit point adjustment (non-linearity, hysteresis, repeatability)

³ additional external overvoltage-protection unit with atmospheric pressure compensation KL 1 or KL 2 available as accessory

⁴ approved for atmospheric pressure from 0.8 bar up to 1.1 bar

LMK 457

Hydrostatic Level Transmitter

Technical Data

Dimensions (in mm)

submersible transmitter

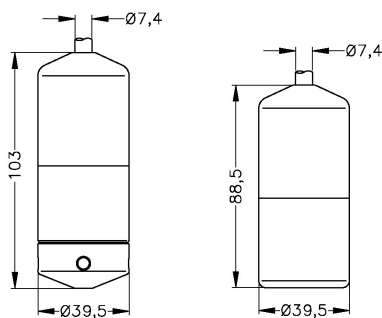

stainless steel

CuNiFe

screw-in transmitter

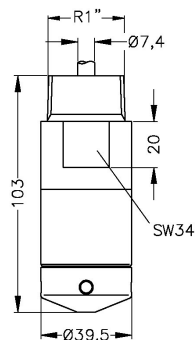

prepared for mounting
with stainless steel pipe

screw-in transmitter

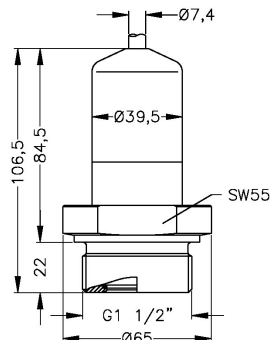

flange transmitter

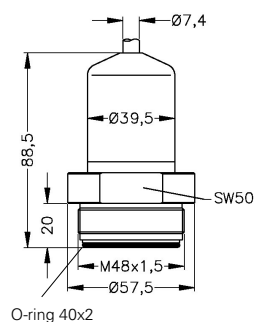

accessories

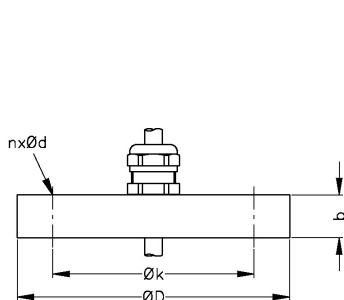

mounting flange⁵

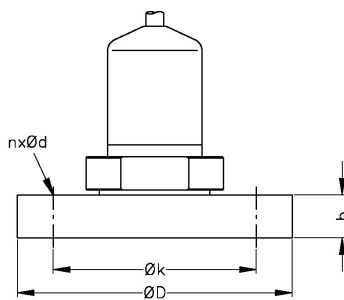

transmitter flange⁵

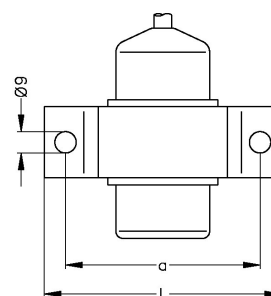

mounting clamp

Flange (DIN 2501)	Dimensions				
	D	k	b	n	d
DN25/PN40	115	85	18	4	14
DN50/PN40	165	125	20	4	18
DN80/PN16	200	160	20	8	18

Mounting clamp material	Dimensions	
	a	L
CuNiFe	82	100
stainless steel	100	130

⁵ DN80/PN16 possible for nominal pressure ranges up to 16 bar

Electrical connection

Cable with cable sheath ⁶	TPE dark blue
Cable protection	standard: without cable protection option stainless steel pipe ⁷ : available as compact product with stainless steel pipe with a total length up to 2 m; other lengths on request

Materials

Housing	standard: stainless steel 1.4571 (316Ti) option: CuNi10Fe1Mn (resistant against sea water) - for submersible transmitter others on request
Seals	FKM, EPDM; others on request
Diaphragm	Standard: ceramics Al ₂ O ₃ 96 % Option: ceramics Al ₂ O ₃ 99.9 % - for pressure ranges from 0.1 bar up to 1 bar
Cable sheath ⁸	TPE

Miscellaneous

Cable capacitance	signal line/shield also signal line/signal line: 160 pF/m
Cable inductance	signal line/shield also signal line/signal line: 1.0 µH/m
Current consumption	max. 21 mA
Weight	approx. 400 g (without cable)
Ingress protection	IP 68

Mounting accessories (not part of the supply)

Transmitter flange for fixing screw-in transmitter, stainless steel 1.4571 (316Ti):

DN25 / PN40 (Ø115, 18 thick, 4 drill holes Ø14 at Ø85)

DN50 / PN40 (Ø165, 20 thick, 4 drill holes Ø18 at Ø125)

DN80 / PN16 (Ø200, 20 thick, 8 drill holes Ø18 at Ø160)

Mounting clamp, stainless steel 1.4571 (316Ti) or CuNiFe

Mounting flange for fixing submersible transmitter, stainless steel 1.4571 (316Ti):

DN25 / PN40 (Ø115, 18 thick, 4 drill holes Ø14 at Ø85)

DN50 / PN40 (Ø165, 20 thick, 4 drill holes Ø18 at Ø125)

DN80 / PN16 (Ø200, 20 thick, 8 drill holes Ø18 at Ø160)

Terminal clamp, stainless steel 1.4301 (304) or steel, zinc plated

Pin configuration

Electrical connection	cable colours (DIN 47100)	
2-wire-system	Supply +	white
	Supply -	brown
	Ground	yellow / green (shield)

Wiring diagram

2-wire-system (current)

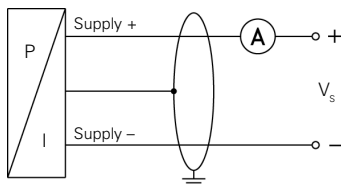

⁶ shielded cable with integrated air tube for atmospheric reference

⁷ not for CuNiFe version

⁸ resistant against sea water, halogen free, temperature resistant up to +125 °

